

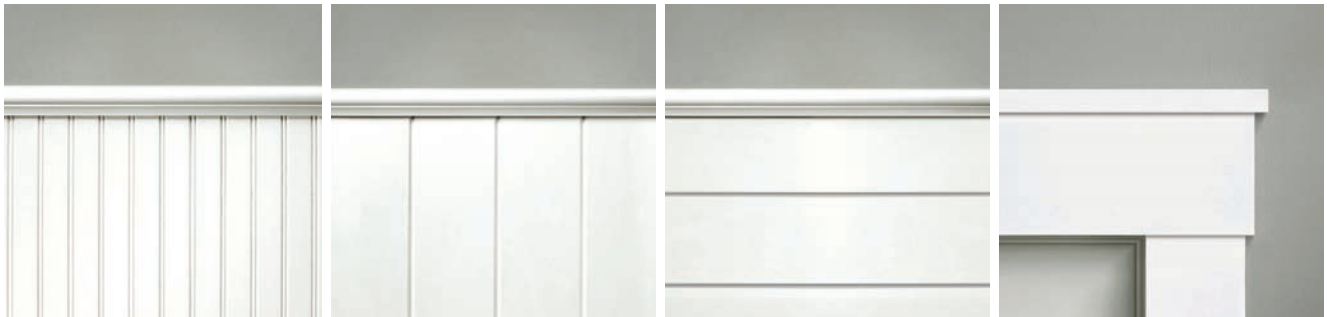

FARMHOUSE

TRIM IDEAS FOR A TRADITIONAL OR MODERN FARMHOUSE

IDEA BOOKS by  WINDSORONE







Fall 2022 | WindsorONE is manufactured in the U.S.A. & available at your local pro lumberyard

BUILD ★ AMERICA 



BEADBOARD

CLASSIC BEADBOARD, PRECISION ENGINEERING

	SPBC4	$\frac{9}{16}$ " x $3\frac{5}{16}$ "
	SPBC6	$2\frac{3}{32}$ " x $5\frac{1}{2}$ "
	SPBC8	$2\frac{3}{32}$ " x $7\frac{1}{4}$ "
	WOBC6	$\frac{3}{4}$ " x $5\frac{3}{8}$ "

Beadboard is a staple of many different home styles, ranging from uses for interior walls to exterior porches. WindsorONE offers straight, tight & true 16' wood boards; Healthy for your home, with precision tongue & groove for an easy install.

CREDITS 1. *Horner Millwork in MA* 2. *Art Guerrero in CA* 3. *Curry Construction in MD* 4. *Joe Denman Carpentry for Baker Barn & Restoration in PA*



1.



2.





3.



4.

V-GROOVE & PLANTATION

	WOTG	$2\frac{3}{32}$ " x $5\frac{1}{2}$ "
	230	$1\frac{1}{16}$ " x $7\frac{1}{2}$ "
	plantation	$\frac{3}{4}$ " x $5\frac{1}{2}$ "





THE TONGUE & GROOVE ALTERNATIVE TO SHIPLAP

V-Groove boards offer the same precision tongue & groove as beadboard, with the more minimalist feel of shiplap. Plantation boards provide the look of rough-sawn or smooth shiplap but without any gap.

CREDITS 1. JAS Design Build in WA 2. Streamline Builders in CA 3. JL Madison General Contractors and Donahue Construction in CA 4. Robert Gamen in CA



SHIPLAP & NICKEL GAP

-  WORS6 3/4" x 5 1/2"
-  WORS8 3/4" x 7 1/4"
-  WOSN6 3/4" x 5 1/2"
-  WOSN8 3/4" x 7 1/4"

VERSATILITY OF SHIPLAP, OR PRE-SET NICKEL GAP

SHIPLAP (WORS): Choose your own gap, reversible, rough or smooth finish & Protected with a 30 year warranty* **NICKEL GAP (WOSN):** Pre-set 3/16" gap every time, smooth finish and available in a Traditional Board only.

CREDITS 1 & 4. *Spillman Contracting in MO* 2. *Collins Company in CA* 3. *Streamline Builders in CA*



1.



2.



3.



4.

S4SSE

STRAIGHT TIGHT & TRUE TRIM BOARDS

1x2	■	5/4x3	■
1x3	■	5/4x4	■
1x4	■	5/4x5	■
1x5	■	5/4x6	■
1x6	■	5/4x8	■
1x8	■	5/4x10	■
1x10	■	5/4x12	■
1x12	■		

VERSATILE Box beam ceilings, wainscoting, built-ins, door & window trim, just to name a few of the applications... Smooth surface on all sides with 4 crisp edges.

CREDITS 1. RW Anderson Homes in collaboration with First Lamp Architecture Construction 2. Compton Homes in AL 3. Streamline Builders in CA 4. Art Guerrero in CA

SCALE

SIZED UP NICKEL GAP,
*a Traditional board with
a pre-set 3/16" gap*

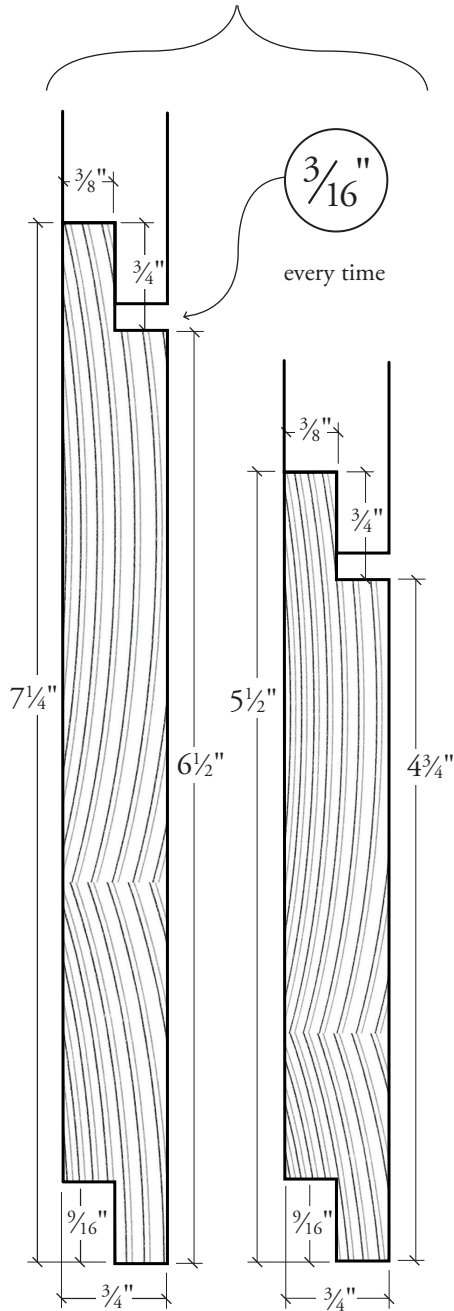

WOSN8

pre-set gap
nickel gap 16'
TR

WOSN6

pre-set gap
nickel gap 16'
TR

REVERSIBLE SHIPLAP,
*smooth on front with a
rough sawn back*

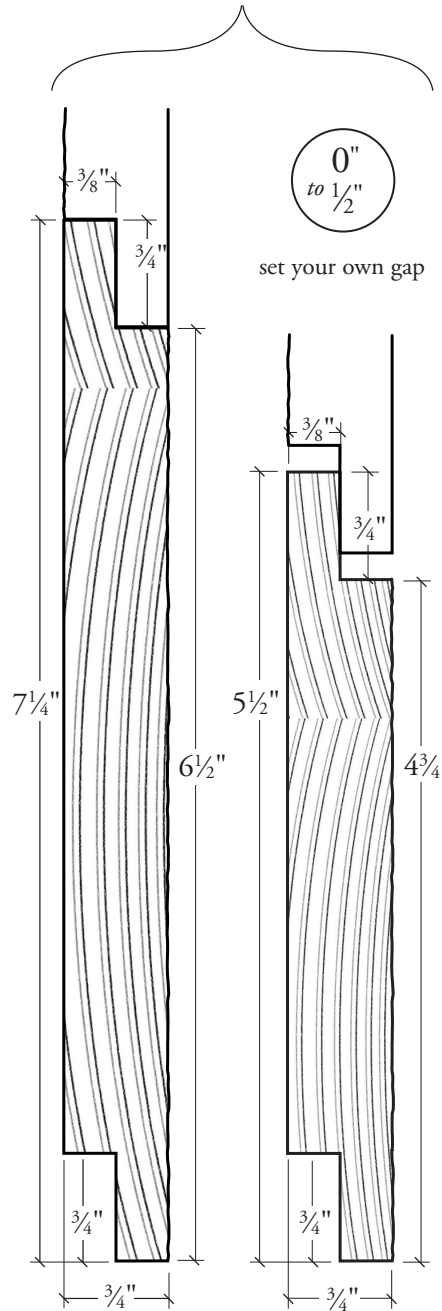

WORS8

reversible
shiplap 16'
30

WORS6

reversible
shiplap 16'
30

REVERSIBLE
PLANTATION
*smooth on front with a
rough sawn back*

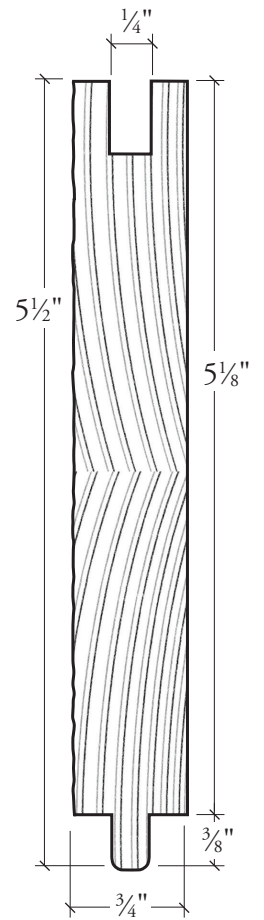

PLANTATION

T&G
board 20'
30

SPECIALTY BOARDS (AVAILABLE WITH WindsorONE PROTECTED 30yr WARRANTY)



2 Types of Boards:
TRADITIONAL or PROTECTED

only
**PROTECTED
HAS THE
30 YEAR
WARRANTY***
*based on proper
installation

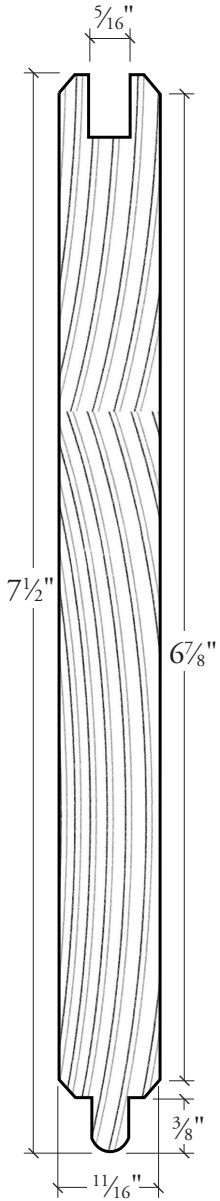

230
T&G
board 16'
30

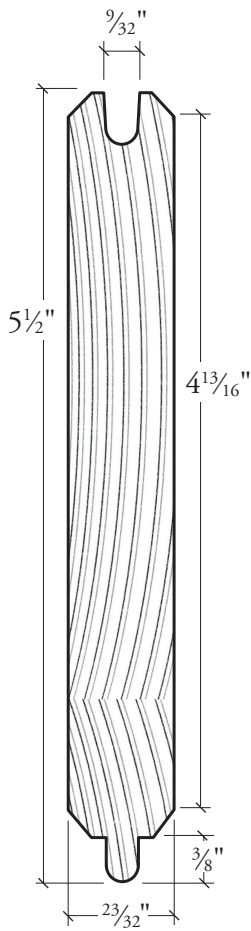

WOTG
T&G
board 16'
30 or TR

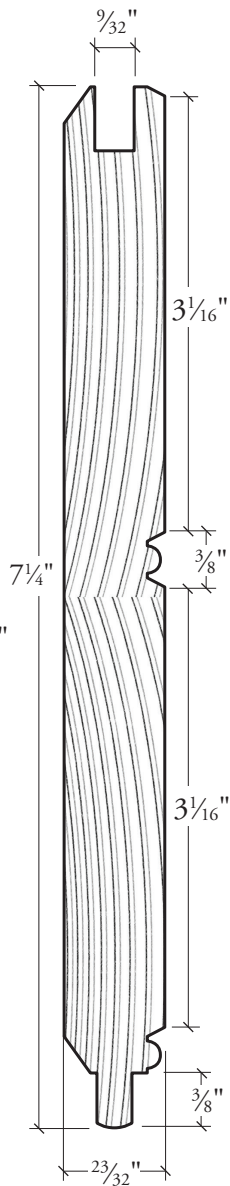

SPBC8
standard T&G
beadboard 16'
30

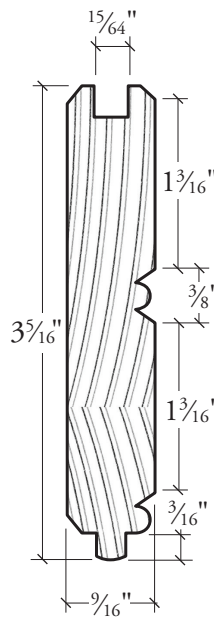

SPBC4
standard T&G
beadboard 16'
30 or TR

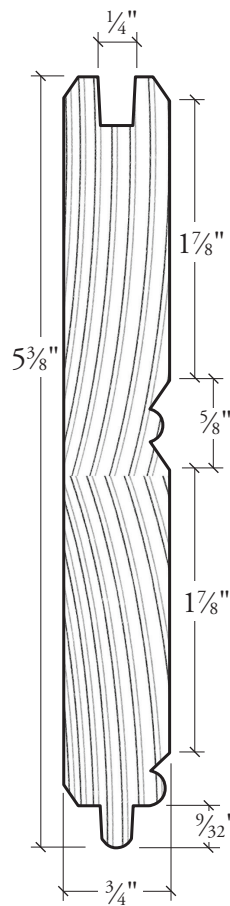

WOTG
wide T&G
beadboard 16'
30 or TR

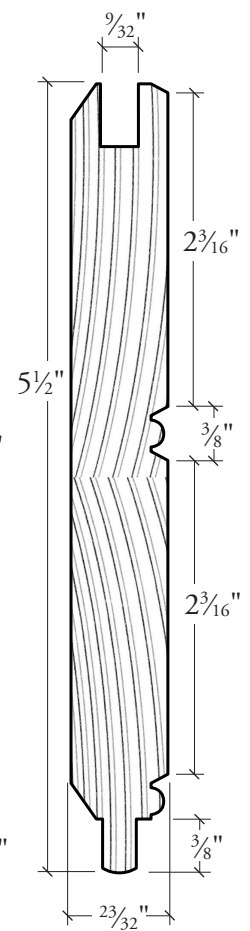

SPBC6
standard T&G
beadboard 16'
30 or TR

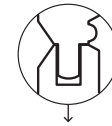

Precision manufacturing
ensures a perfect fit.

NOTE: Not
all profiles are
compatible.

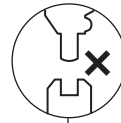



S4S TRIM



V-GROOVE & *plantation*

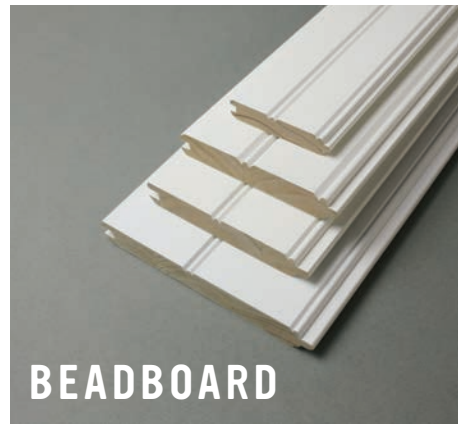

BEADBOARD

NARROW BOARD & BATTEN



WOTG *vertical*



SPBC4



SQUARES GRID



PLANTATION *horizontal, smooth side*

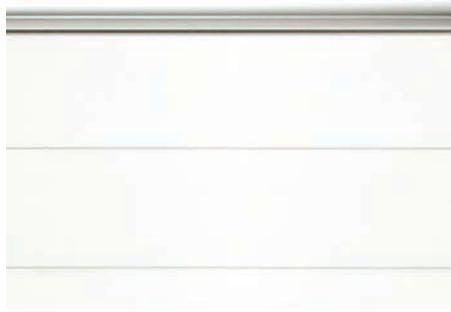

SPBC6 *compare to WOBC6 wide bead*



SPLIT STILES RAILS



230



SPBC8



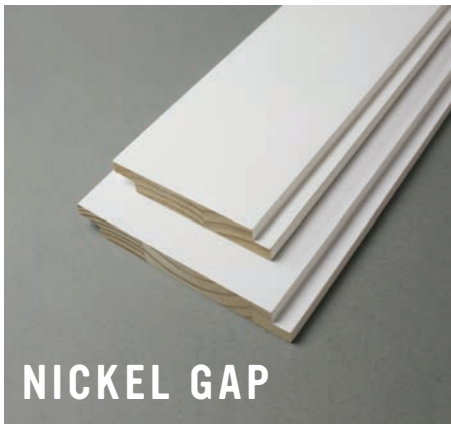

NICKEL GAP



SHIPLAP *smooth side out*



SHIPLAP *rough side out*



PRE-SET 3/16"
3/16" reveal every time



CHOOSE YOUR OWN GAP
shown: 1/2" reveal, smooth side out



CHOOSE YOUR OWN GAP
shown: 3/16" reveal, rough side out

WOSN8 *always a 3/16" gap*



WORS6 *smooth side out, 3/16" gap*



WORS8 *rough side out, 1/2" gap*



WOSN6 *always a 3/16" gap*



WORS8 *smooth side out*



WORS6 *rough side, nickel gap, horizontal*





MODERN FARMHOUSE ELEMENTS

A KEY INGREDIENT FOR A MODERN LOOK: SHIPLAP

Contrasting accents in black, a metal roof and a homage to the architectural features of the more classic farmhouses help create this look. Shiplap lines help compose the room by bringing the eyes to various focal points of the space.

CREDITS 1-2, 4, 6-10. *Special thanks to Woods Architecture, LLC and Seven Development in AZ 3, 8. Dave Bell in CA 5. Homeowner in CA*





TRADITIONAL FARMHOUSE ELEMENTS

PRECISION BOARDS FOR A CLASSIC LOOK

Look for WindsorONE Protected Boards with a 30 year warranty against rot, insects & mold; industry leading technology to restore or recreate looks from previous centuries. All WindsorONE products have a Gold Indoor Air Quality Rating for a healthy home.

CREDITS 1-4, 9. *WindsorONE Archive* 5. *Art Guerrero in CA* 6, 8. *Hull Historical in TX* 7. *4 Chicks Furniture in CO* 10. *Woodwork Solutions in CA*

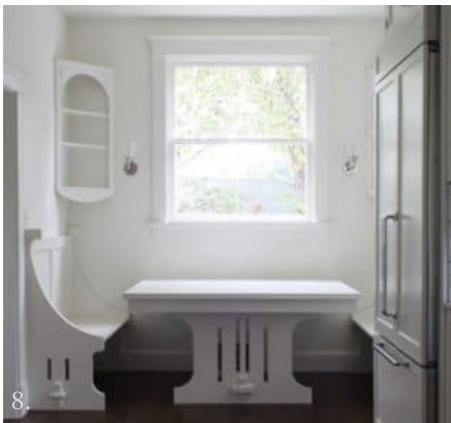

BARN DOORS & STAIN GRADE ACCENTS

BARN DOORS are a hallmark of Farmhouse Style, and can also incorporate WindsorONE specialty & trim boards.

STAIN GRADE ACCENTS Work well against the white textures created by Shiplap & V-Groove boards.

CREDITS 1. *Woodwork Solutions in CA* 2&4. *Spillman Contracting in MO* 3. *Streamline Builders in CA* 5. *Woods Architecture, LLC and Seven Development in AZ* 6. *Mission Construction in CA* 7. *Greg Bender Custom in TX*





CASING & MANTEL IDEAS

1. S4S MINIMALIST Scale up or down with S4SSE Trim Boards
2. S4S BUNGALOW Paired down version of option #4
3. S4S PICTURE FRAME Run a 1x2 around the border of option #1
4. S4S CRAFTSMAN A popular S4S casing option, for profile options see WindsorONE.com

CREDITS

*Overmantel & Mantel photos:
Streamline Builders in CA*



2 TYPES OF BOARDS

TR TRADITIONAL OR **30** PROTECTED



TRADITIONAL S4SSE TRIM

smooth surface four sides

nominal sizes | 12' 16' 20'

	1x2	e .
	1x3	e .
	1x4	e . w
	1x5	e . w
	1x6	e . w
	1x8	e . w
	1x10	e . w
	1x12	e . w
	5/4x3	.
	5/4x4	e .
	5/4x5	e .
	5/4x6	e .
	5/4x8	e .
	5/4x10	e .
	5/4x12	e .

TRADITIONAL TONGUE & GROOVE

	SPBC4	9/16" x 3 5/16"
	SPBC6	2 3/32" x 5 1/2"
	WOBC6	3/4" x 5 3/8"
	WOTG	2 3/32" x 5 1/2"

PROTECTED TONGUE & GROOVE

	SPBC4	9/16" x 3 5/16"
	SPBC6	2 3/32" x 5 1/2"
	SPBC8	2 3/32" x 7 1/4"
	WOBC6	3/4" x 5 3/8"
	WOTG	2 3/32" x 5 1/2"
	230	1 1/16" x 7 1/2"
	plantation	3/4" x 5 1/2"

TRADITIONAL NICKEL GAP**

	WOSN6	3/4" x 5 1/2"
	WOSN8	3/4" x 7 1/4"

PROTECTED SHIPLAP**

	WORS6	3/4" x 5 1/2"
	WORS8	3/4" x 7 1/4"

PROTECTED S4SSE TRIM

smooth surface four sides

nominal sizes | 12' 16' 20'

	1x2	e .
	1x3	e .
	1x4	e . w
	1x5	e . w
	1x6	e . w
	1x8	e . w
	1x10	e . w
	1x12	e . w
	5/4x3	.
	5/4x4	e .
	5/4x5	e .
	5/4x6	e .
	5/4x8	e .
	5/4x10	e .
	5/4x12	e .

PROTECTED S1S2E TRIM

*reversible rough sawn on one side,
smooth on others with eased edges*

nominal sizes | 16' 20'

	1x2	w w
	1x3	w w
	1x4	w w
	1x6	w w
	1x8	w w
	1x10	w w
	1x12	w w
	5/4x3	w w
	5/4x4	w w
	5/4x6	w w
	5/4x8	w w
	5/4x10	w w
	5/4x12	w w
	2x2	w w
	2x4	w w
	2x6	w w
	2x8	w w
	2x10	w w
	2x12	w w

**Nickel Gap is pre-gapped, Shiplap is choose your own gap, more at WindsorONE.com.

KEY: e = east coast, w = west coast, . = both



1 PROTECTED TO THE CORE; FULL PENETRATION

Because unlike the other guys, we're assuming you'll actually want to cut the material at some point.



2 PROTECTED AGAINST ROT, INSECTS & MOLD

Does *not* protect against your mother-in-law, hangovers, airport security, etc.



3 DURABLE FOR EXTERIOR & SAFE FOR INTERIOR

Gold Indoor Air Quality Rating, low VOC's and California Hippie Approved.



4 WEATHER RESISTANT SYSTEM (WRS™)

Water is for drinking, not trim boards.



5 MINIMIZES THE NATURAL TENDENCY TO DISTORT

Unlike the explanation your 16 yr old told you about how the family car ended up in the pond out on Rte 1.



6 NO KNOTS; YOUR BOARDS ARE ALWAYS CLEAR

Imagine that, you can actually use every foot you pay for.



7 PROTECTION NOT DIMINISHED

By shaping, planing, sanding, fastening or molding (actual use does not void the warranty).



8 THE CUT SURFACES ONLY NEED PRIMING

No need to also apply special protection (we took care of that for you).



9 BACKED BY A 30-YEAR LIMITED* WARRANTY

The "limitation" is you have to install it correctly (for one example see #8 again).



10 BUILD AMERICA: MANUFACTURED IN THE U.S.A.

Because everything else you bought was made in China.

INSTALLATION REMINDERS*



PRIME ALL CUTS!

MOISTURE CONTROL¹: Acclimate to the environment. For interior trim, store inside the structure until the products reach approx 8% moisture content. For exterior trim, store in locations such as a garage that is not heated & is well ventilated until about 14% moisture content. Do not install exterior trim boards with a moisture content over 18%. ¹see www.windsorone.com/moisturecontrol



KEEP MATERIAL COVERED: Store on stringers and out of the weather.



INSTALL 6" ABOVE GRADE: Trim should be installed always at least 6" from ground.



INSTALL 2" ABOVE ROOF: 2" breaks are crucial on the roof and flat surfaces (porches, decks, etc).

1/4" FROM FLASHING: Flashing is imperative; and always maintain a 1/4" gap for a capillary break.

*** SEE FULL INSTALLATION INSTRUCTIONS.** WindsorONE should be stored, installed, handled & maintained correctly for the best performance. For complete installation guidelines & the WindsorONE Protected warranty, visit WindsorONE.com/install or call 888.229.7900.